

# Architectural Concrete Masonry

## Profile and Size by Colour

01/11/2006

### # 591 Manitoba Stone



100 mm										
100 mm Full Split Face	100 mm Full Split L- Corner	100 mm Split Ledge	100 mm Split Ledge Corner	100 mm Full Split Half High	100 mm 4 Rib Split Face*	100 mm 4 Rib Return*	100 mm Smooth Face Half High*	100 mm Smooth Face	100 mm Smooth Face Single Score*	100 mm Smooth Face L- Corner
96 W 190 H 390 L	96 W 190 H 390 L	96 W 190 H 390 L	96 W 190 H 295 L	96 W 90 H 390 L	96 W 190 H 390 L	96 W 190 H 390 L	90 W 90 H 390 L	90 W 190 H 390 L	90 W 190 H 390 L	90 W 190 H 390 L

200 mm				250 mm	
200 mm Sill Block	200 mm Full Split Face	200 mm Full Split Half High	200 mm Smooth Face	250 mm Full Split Face	250 mm Smooth Face*
190 W 390 H 190 L	196 W 190 H 390 L	196 W 90 H 390 L	190 W 190 H 390 L	246 W 190 H 390 L	240 W 190 H 390 L

### # 205 Biege



100 mm Full Split Face	100 mm Full Split L- Corner	100 mm Full Split Half High	100 mm Smooth Face Half High*	100 mm Smooth Face	100 mm Smooth Face Single Score*	100 mm Smooth Face L- Corner
96 W 190 H 390 L	96 W 190 H 390 L	96 W 90 H 390 L	90 W 90 H 390 L	90 W 190 H 390 L	90 W 190 H 390 L	90 W 190 H 390 L

200 mm Full Split Face	200 mm Full Split Half High	200 mm Smooth Face	250 mm Full Split Face	250 mm Smooth Face*
196 W 190 H 390 L	196 W 90 H 390 L	190 W 190 H 390 L	246 W 190 H 390 L	240 W 190 H 390 L

### # 305 Charcoal



100 mm Full Split Face	100 mm Full Split L- Corner	100 mm Full Split Half High	100 mm 4 Rib Split Face*	100 mm 4 Rib Return*	100 mm Smooth Face Half High*	100 mm Smooth Face	100 mm Smooth Face Single Score*	100 mm Smooth Face L- Corner
96 W 190 H 390 L	96 W 190 H 390 L	96 W 90 H 390 L	96 W 190 H 390 L	96 W 190 H 390 L	90 W 90 H 390 L	90 W 190 H 390 L	90 W 190 H 390 L	90 W 190 H 390 L

200 mm Sill Block	200 mm Full Split Face	200 mm Full Split Half High	200 mm Smooth Face	250 mm Full Split Face	250 mm Smooth Face*
190 W 390 H 190 L	196 W 190 H 390 L	196 W 90 H 390 L	190 W 190 H 390 L	246 W 190 H 390 L	240 W 190 H 390 L

### # 405 Burgundy



100 mm Full Split Face	100 mm Full Split L- Corner	100 mm Full Split Half High	100 mm Smooth Face Half High*	100 mm Smooth Face	100 mm Smooth Face Single Score*	100 mm Smooth Face L- Corner
96 W 190 H 390 L	96 W 190 H 390 L	96 W 90 H 390 L	90 W 90 H 390 L	90 W 190 H 390 L	90 W 190 H 390 L	90 W 190 H 390 L

200 mm Sill Block	200 mm Full Split Face	200 mm Full Split Half High	200 mm Smooth Face	250 mm Full Split Face	250 mm Smooth Face*
190 W 390 H 190 L	196 W 190 H 390 L	196 W 90 H 390 L	190 W 190 H 390 L	246 W 190 H 390 L	240 W 190 H 390 L

### # 505 Natural Grey



100 mm Full Split Face	100 mm Full Split L- Corner	100 mm Full Split Half High	100 mm 4 Rib Split Face*	100 mm 4 Rib Return*	100 mm Smooth Face Half High*	100 mm Smooth Face	100 mm Smooth Face L- Corner
96 W 190 H 390 L	96 W 190 H 390 L	96 W 90 H 390 L	96 W 190 H 390 L	96 W 190 H 390 L	90 W 90 H 390 L	90 W 190 H 390 L	90 W 190 H 390 L

200 mm Sill Block	200 mm Full Split Face	200 mm Full Split Half High	200 mm Smooth Face	250 mm Full Split Face	Common Brick
190 W 390 H 190 L	196 W 190 H 390 L	196 W 90 H 390 L	190 W 190 H 390 L	246 W 190 H 390 L	4 W 2 1/4 H 8 L



200 mm Single Score	200 mm Three Score	200 mm Smooth Face	250 mm Single Score
190 W 190 H 390 L	190 W 190 H 390 L	190 W 190 H 390 L	240 W 190 H 390 L

\* Special Order Items

**Colour**      **Profile and Size by Colour**

**# 606 Brick Red**

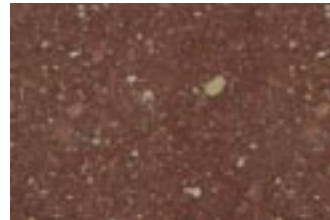

**100 mm**

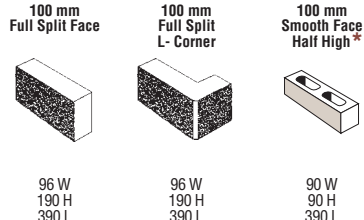

**# 990 White**

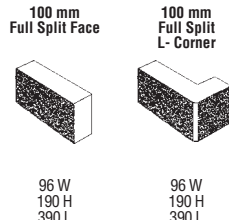

**# 705 Maize**

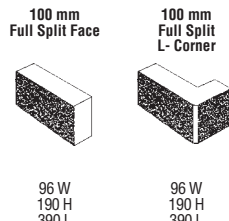

**# 805 Sage**

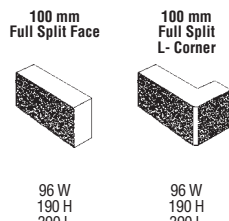

**# 905 Chocolate**

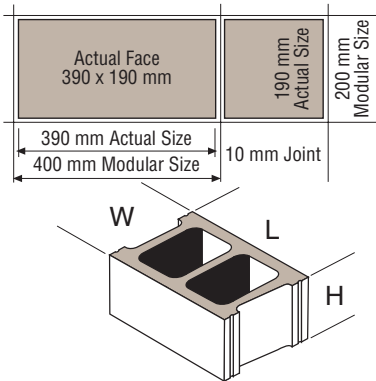
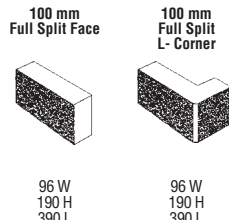

**\* Special Order Items**

Although we have tried to match these swatches as close to production run colours as possible, actual block colours may vary. For actual colour samples contact the Concrete Masonry Sales department at: